



JBL CINEMA SB190



OWNER'S MANUAL

IMPORTANT SAFETY INSTRUCTIONS

Verify Line Voltage Before Use

The JBL CINEMA BAR 190 (soundbar and subwoofer) has been designed for use with 100-240 volt, 50/60 Hz AC current. Connection to a line voltage other than that for which your product is intended can create a safety and fire hazard and may damage the unit. If you have any questions about the voltage requirements for your specific model or about the line voltage in your area, contact your retailer or customer service representative before plugging the unit into a wall outlet.

Do Not Use Extension Cords

To avoid safety hazards, use only the power cord supplied with your unit. We do not recommend that extension cords be used with this product. As with all electrical devices, do not run power cords under rugs or carpets, or place heavy objects on them. Damaged power cords should be replaced immediately by an authorized service center with a cord that meets factory specifications.

Handle the AC Power Cord Gently

When disconnecting the power cord from an AC outlet, always pull the plug; never pull the cord. If you do not intend to use this speaker for any considerable length of time, disconnect the plug from the AC outlet.

Do Not Open the Cabinet

There are no user-serviceable components inside this product. Opening the cabinet may present a shock hazard, and any modification to the product will void your warranty. If water accidentally falls inside the unit, disconnect it from the AC power source immediately, and consult an authorized service center.

TABLE OF CONTENTS

IMPORTANT SAFETY INSTRUCTIONS	2	7 SOUND SETTINGS	13
		7.1 DOLBY ATMOS® (VIRTUAL)	13
		7.2 PRE-DEFINED EQ SETTINGS	13
		7.3 VOICE MODE	14
		7.4 BASS BOOST	14
1 INTRODUCTION	4		
2 WHAT'S IN THE BOX	4	8 RESTORE FACTORY SETTINGS	15
3 PRODUCT OVERVIEW	5	9 SOFTWARE UPDATE	15
3.1 CONTROLS AND INDICATORS	5	10 RE-CONNECT THE SUBWOOFER	16
3.2 CONNECTORS	5	11 PRODUCT SPECIFICATIONS	16
3.3 SUBWOOFER	5	12 TROUBLESHOOTING	17
3.4 REMOTE CONTROL	6	13 TRADEMARKS	18
4 PLACE	7		
4.1 DESKTOP PLACEMENT	7		
4.2 WALL-MOUNTING	7		
5 CONNECT	8		
5.1 CONNECTION WITH YOUR TV AND DIGITAL DEVICES	8		
5.2 BLUETOOTH CONNECTION	10		
6 PLAY	11		
6.1 POWER-ON/AUTO STANDBY/AUTO WAKEUP	11		
6.2 PLAY FROM THE TV SOURCE	11		
6.3 PLAY FROM THE HDMI IN SOURCE	12		
6.4 PLAY FROM THE BLUETOOTH SOURCE	12		

1 INTRODUCTION

Thank you for purchasing the JBL CINEMA BAR 190 (soundbar and subwoofer) which is designed to bring an extraordinary sound experience to your home entertainment system. We encourage you to take a few minutes to read through this manual, which describes the product and includes step-by-step instructions for setting up and getting started.

To make the most of product features and support, you may need to update the product software through the USB connector in the future. Refer to the software update section in this manual to ensure that your product has the latest software.

Designs and specifications are subject to change without notice. If you have any questions about the soundbar, installation or operation, please contact your retailer or customer service representative, or visit our website: www.jbl.com.

2 WHAT'S IN THE BOX

Unpack the box carefully and ensure that the following parts are included. If any part is damaged or missing, do not use it and contact your retailer or customer service representative.

Main unit



Subwoofer

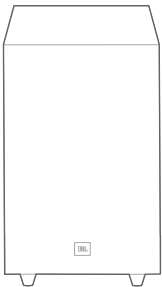

Remote control (with 2 AAA batteries)

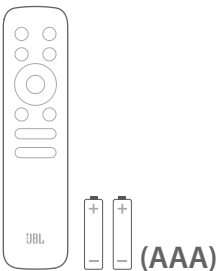

Power cord*

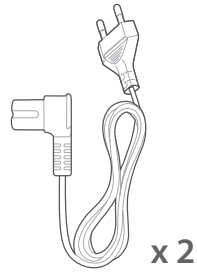

* Power cord quantity and plug type vary by region.

HDMI cable

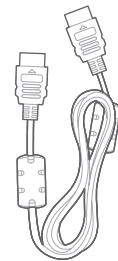

Wall-mounting kit

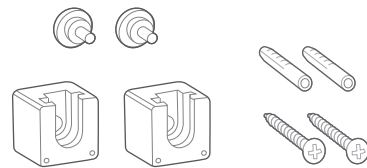

Product information & wall-mounting template



3 PRODUCT OVERVIEW

3.1 Controls and indicators

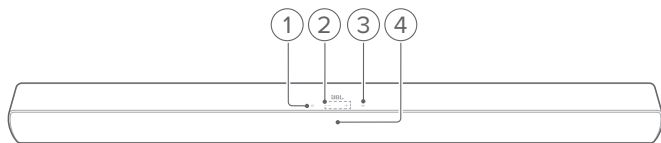

1. **⏻ (Power)**
 - Switch on or to standby
2. **-/+ (Volume)**
 - Decrease or increase the volume
 - Press and hold to decrease or increase the volume continuously
 - Press the two buttons together to mute or unmute
3. **⏮ (Source)**
 - Select a sound source: **HDMI ARC** (default, TV connected through the **HDMI OUT (TV ARC / TV eARC)** connector), **HDMI IN** (digital device connected through the **HDMI IN** connector), **Optical** (TV / digital device connected through the **OPTICAL** connector), or **Bluetooth**
4. **Status indicators**

●	Solid red	Entering standby mode
○	Solid white	HDMI ARC source selected
●	Solid yellow	HDMI IN source selected
●	Solid amber	Optical source selected
●	Solid blue	Connected to Bluetooth
●	Fast flashing blue	Entering Bluetooth pairing mode
●	Solid green	Playing Dolby Atmos audio
\	Flashing (current sound source)	Volume change ongoing
\	Slow flashing (current sound source)	Maximum / minimum volume level reached
\	Continuous slow flashing (current sound source)	Sound muted

3.2 Connectors

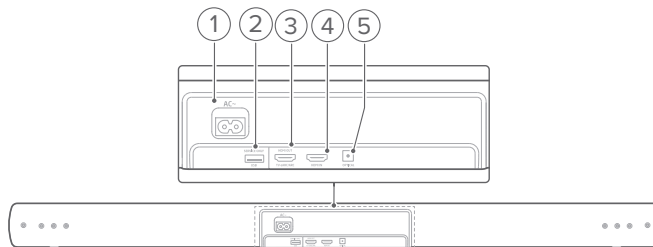

1. **AC~**
 - Connect to power
2. **USB**
 - USB connector for software update
 - Connect to a USB storage device for audio play (for the US version only)
3. **HDMI OUT (TV ARC/ TV eARC)**
 - Connect to the HDMI ARC / HDMI eARC input on your TV
4. **HDMI IN**
 - Connect to the HDMI output on your digital device
5. **OPTICAL**
 - Connect to the optical output on your TV or digital device

3.3 Subwoofer

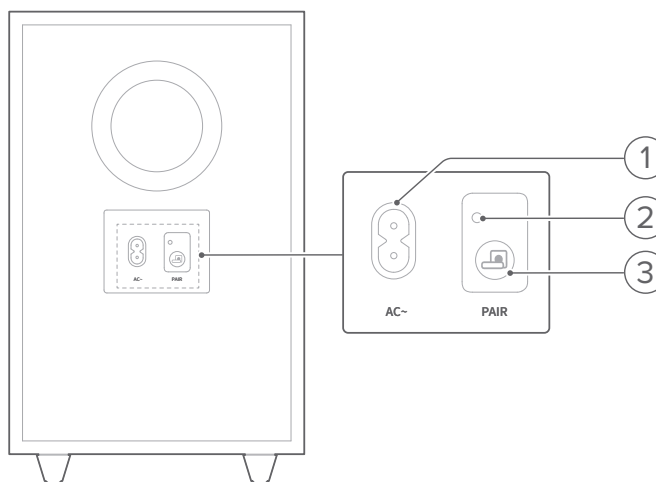

1. **AC~**
 - Connect to power
2. **Connection status indicator**

●	Solid amber	Connected to the soundbar
●	Fast flashing amber	Pairing mode
●	Slow flashing amber	Standby mode

3. **🔌**
 - Press and hold to reconnect the subwoofer with the soundbar

3.4 Remote Control

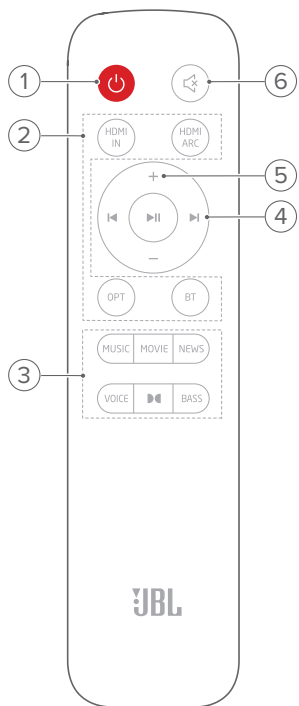

1.

- Switch on or to standby

2. Source selectors

HDMI IN

- Select the HDMI IN source

HDMI ARC

- Select the HDMI ARC source

OPT

- Select the Optical source

BT

- Select the Bluetooth source
- Press and hold to connect another Bluetooth device

3. Sound effect buttons

NEWS / MUSIC / MOVIE

- Select the pre-defined EQ (equalizer) settings for news/ music/ movie

VOICE

- Select the voice mode to enhance vocal clarity



- Switch on or off the virtual Dolby Atmos® sound effects (Default: on)

BASS

- Switch on or off the bass boost (Default: on)

4. Playback buttons



- Bluetooth source: Skip to the previous or next track



- Bluetooth source: Start or pause playback

5. + / -

- Increase or decrease the volume
- Press and hold to increase or decrease the volume continuously.

6. (Mute)

- Mute/unmute

4 PLACE

4.1 Desktop placement

Place the soundbar and subwoofer on a flat and stable surface. Make sure that the subwoofer is at least 3 ft (1 m) away from the soundbar, and 4" (10 cm) away from a wall.

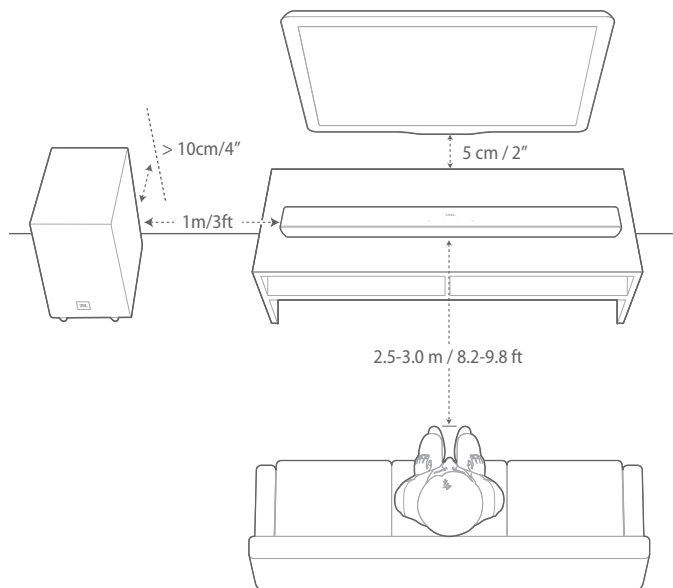

NOTES:

- The power cord shall be properly connected to power.
- Do not place any objects on the top of the soundbar or subwoofer.
- Make sure that the distance between the subwoofer and the soundbar is less than 20 ft (6 m).

4.2 Wall-mounting

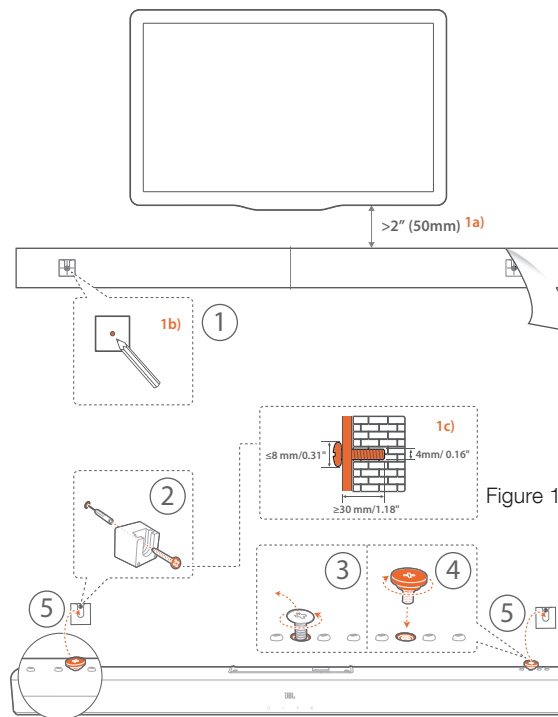

Figure 1

1. Preparation:

- With a minimum distance of 2" (50mm) from your TV, stick the supplied wall-mounting template to a wall by using adhesive tapes.
- Use your ballpen tip to mark the screw holder location. Remove the template.
- On the marked location, drill a 4 mm/0.16" hole. Refer to Figure 1 for the screw size.

2. Install the wall-mounting bracket.

- As shown in the diagram, remove the fastening screw by using a screwdriver.

- Fasten the wall-mounting screw included in the supplied mounting kit.

5. Mount the soundbar.

NOTES:

- Make sure that the wall can support the weight of the soundbar.
- Install on a vertical wall only.
- Avoid a location under high temperature or humidity.
- Before wall-mounting, make sure that cables can be properly connected between the soundbar and external devices.
- Before wall-mounting, make sure that the soundbar is unplugged from power. Otherwise, it may cause an electric shock.

5 CONNECT

5.1 Connection with your TV and digital devices

For audio playback through the soundbar, connect the soundbar with your TV through the supplied HDMI cable or an optical cable (sold separately).

An HDMI connection supports digital audio and video with a single connection. HDMI connectivity is the best option for your soundbar.

TV (HDMI ARC)

(Recommended connection for the best Dolby Atmos experience)

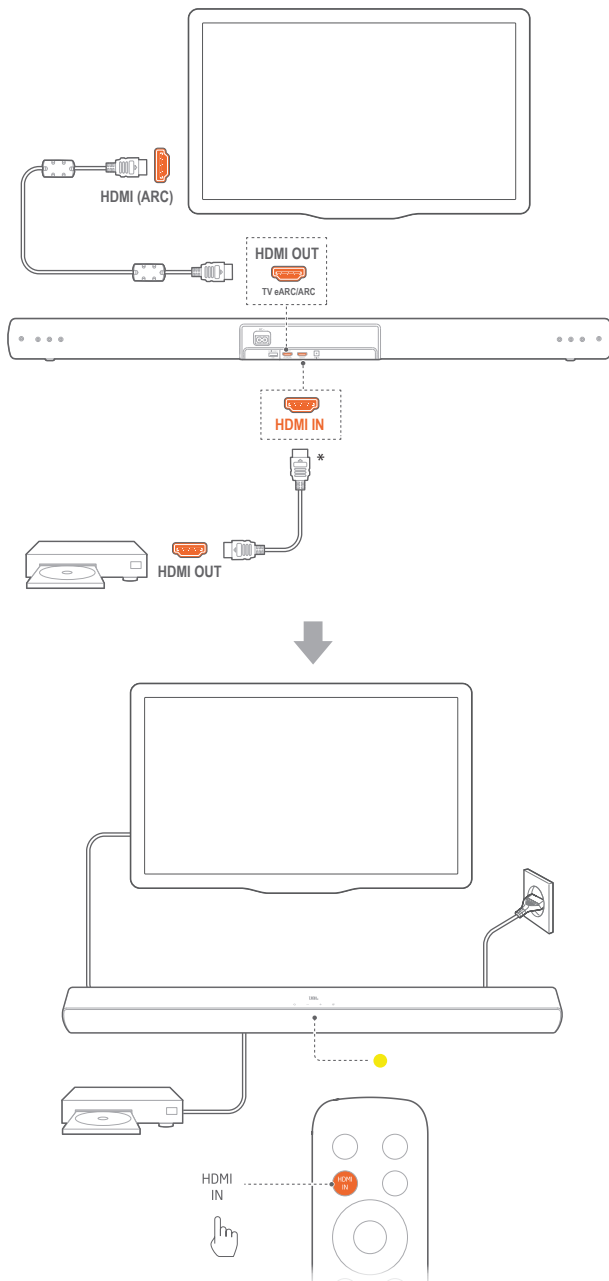

1. Connect the soundbar with the HDMI IN (ARC) connector on your TV by using the supplied HDMI cable.
 - On your TV, check that HDMI-CEC and HDMI ARC have been enabled. Refer to the owner's manual of your TV for more information.
2. Use an HDMI cable (V2.0 or later) to connect the soundbar with your digital device, such as a set-top box, DVD/Blu-ray player or game console.
 - On your digital device, check that HDMI-CEC has been enabled. Refer to the owner's manual of your digital device for more information.
 - On your digital device, select "Bitstream" or "Raw data" in the audio output settings for the best Dolby Atmos experience.
3. To play audio from the digital device connected to the soundbar, select **HDMI IN** on the remote control.

NOTES:

- If your TV does not support HDMI eARC, make sure that you connect your digital device through the HDMI IN connector on the soundbar instead of your TV. Otherwise, the Dolby Atmos information cannot pass through the HDMI (ARC / eARC) connectors to the soundbar.

TV (HDMI eARC)

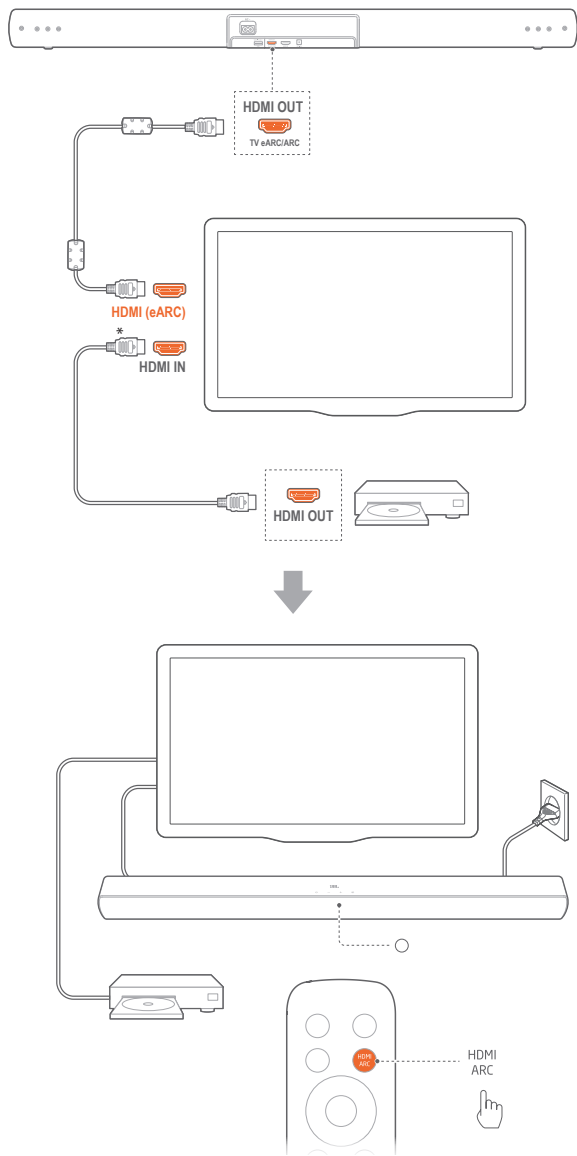

1. Connect the soundbar with the **HDMI IN (eARC)** connector on your TV by using the supplied HDMI cable.
 - On your TV, check that HDMI-CEC and HDMI eARC have been enabled. Refer to the owner's manual of your TV for more information.
2. Use an HDMI cable (eARC compatible, V2.0 or later) to connect your TV with your digital device, such as a streaming device, set-top box, DVD/Blu-ray player or game console.
 - On your digital device, check that HDMI-CEC has been enabled. Refer to the owner's manual of your digital device for more information.
 - On your TV and digital device, select "Bitstream" or "Raw data" in the audio output settings for the best Dolby Atmos experience.
3. To play audio from the digital device connected to your TV, select **HDMI ARC** on the remote control.

OPTICAL

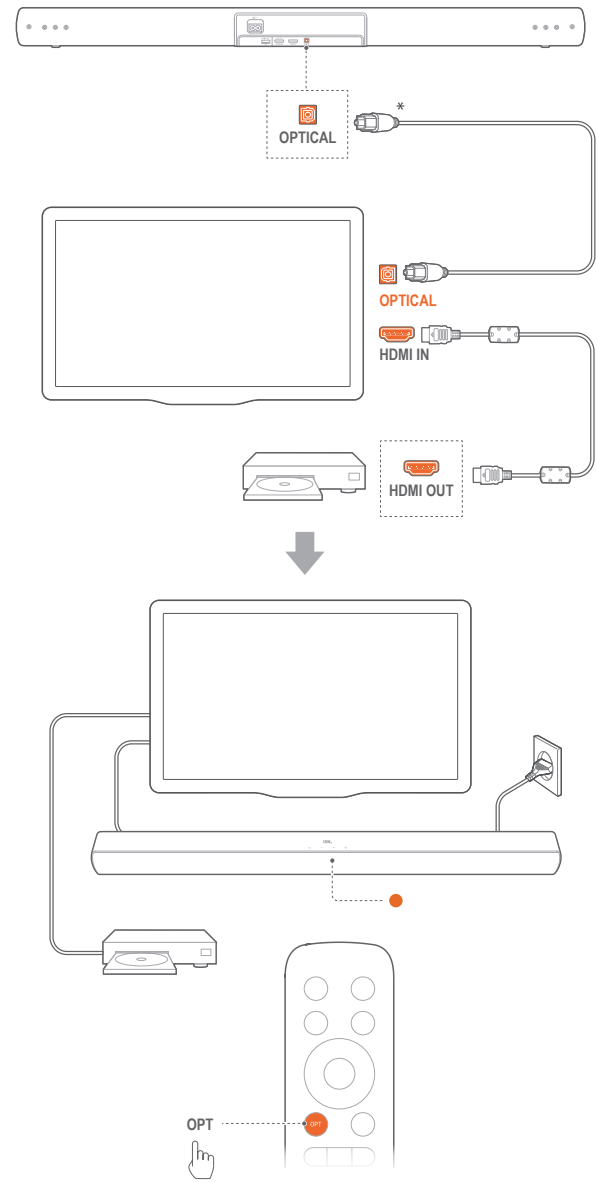

NOTES:

- With the Virtual Dolby Atmos design, the Dolby surround upmixer of the soundbar can expand the legacy channel-based audio of Dolby Digital format, including 5.1 and 7.1 content, and provide an immersive 3D Atmos experience.

1. Connect the soundbar with your TV by using an optical cable.
2. Use an HDMI cable (V2.0 or later) to connect your TV with your digital device, such as a streaming device, set-top box, DVD/Blu-ray player or game console.
3. To play audio through the optical cable, select **OPT** on the remote control.

NOTES:

- * The HDMI cable (for digital device connection) and the optical cable are sold separately.
- Full compatibility with all HDMI-CEC devices is not guaranteed.

5.2 Bluetooth connection

Through Bluetooth, connect the soundbar with your Bluetooth device, such as a smartphone, tablet and laptop.

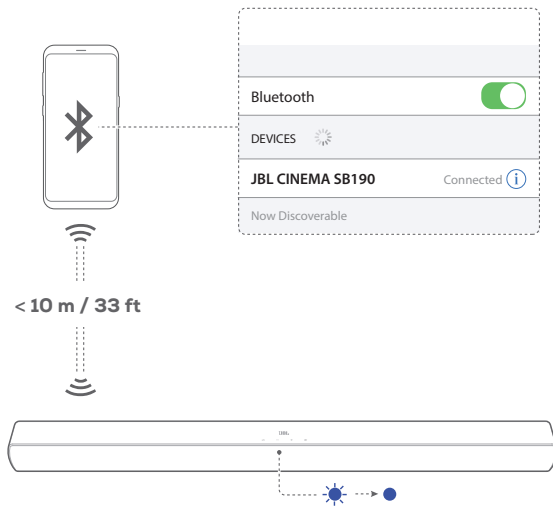

Connect a Bluetooth device

1. Press \odot to switch on (See “6.1 Power-on/Auto standby/Auto wakeup” in the “6 PLAY” chapter).
2. To select the Bluetooth source, press \odot on the soundbar or \mathbb{B} on the remote control.
→ Ready for pairing: The status indicator flashes blue.
3. On your Bluetooth device, enable Bluetooth and search for “JBL CINEMA SB190” within three minutes.
→ Connected: The status indicator lights up solid blue. A confirmation tone is heard.

To reconnect the last paired device

Your Bluetooth device is retained as a paired device when the soundbar goes to standby mode. Next time you switch to the Bluetooth source, the soundbar reconnects the last paired device automatically.

To connect to another Bluetooth device

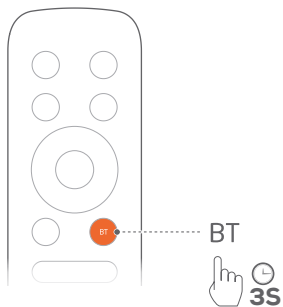

1. In the Bluetooth source, press and hold \odot on the soundbar or \mathbb{B} on the remote control until the status indicator flashes blue.
→ The soundbar enters the Bluetooth pairing mode. The status indicator flashes blue.

2. Follow Step 3 under “Connect a Bluetooth device”.

- If the device has ever been paired with the soundbar, first unpair “JBL CINEMA SB190” on the device.

NOTES:

- The Bluetooth connection will be lost if the distance between the soundbar and Bluetooth device exceeds 33 ft (10 m).
- Electronic devices may cause radio interference. Devices that generate electromagnetic waves must be kept away from the soundbar, such as microwaves and wireless LAN devices.

6 PLAY

6.1 Power-on/Auto standby/Auto wakeup

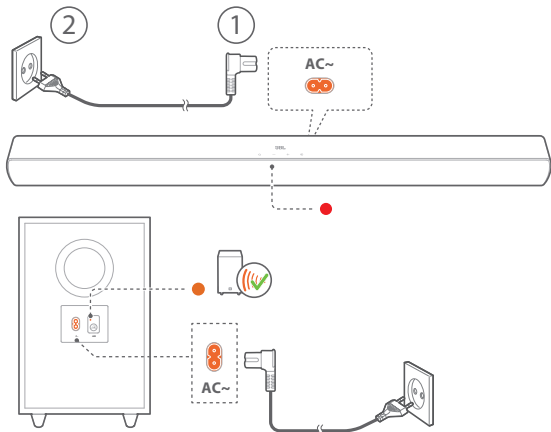

Switch on

1. Connect the soundbar and subwoofer to power by using the supplied power cords.
2. Press \cup to switch on.
 - The subwoofer is connected to the soundbar automatically. Connected: The connection status indicator turns solid amber (●).

NOTES:

- Use the supplied power cord only.
- Before switching on the soundbar, make sure that you have completed all other connections (See “5.1 Connection with your TV and digital devices” in the “5 CONNECT” chapter).

Auto standby

If the soundbar is inactive for more than 10 minutes, it will switch to standby mode automatically. The subwoofer also goes to standby, and the connection status indicator turns slow flashing amber (●).

Next time you switch on the soundbar, it returns to the last selected source.

Auto wakeup

In standby mode, the soundbar will wake up automatically when

- the soundbar is connected to your TV through the HDMI ARC connection and your TV is switched on;
- the soundbar is connected to your TV through an optical cable and audio signals are detected from the optical cable.

6.2 Play from the TV source

With the soundbar connected, you can enjoy TV audio from the soundbar speakers.

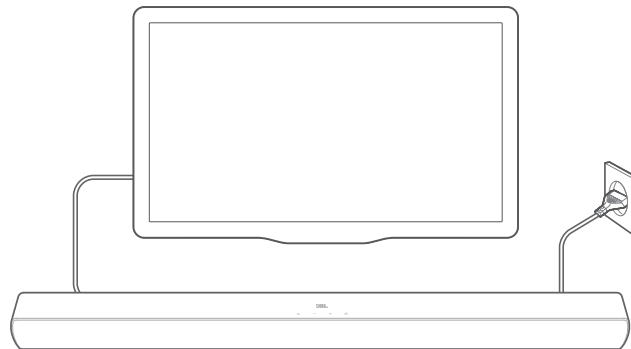

1. Make sure that your TV is set to support external speakers and the built-in TV speakers are disabled. Refer to the owner's manual of your TV for more information.
2. Make sure that the soundbar has been properly connected to your TV (See “5.1 Connection with your TV and digital devices” in the “5 CONNECT” chapter).
3. To select the TV source, press \mathbb{G} on the soundbar or **HDMI ARC / OPT** on the remote control.
 - The status indicator turns solid white (○), if you play from the **HDMI ARC** source.
 - The status indicator turns solid amber (●), if you play from the **Optical** source.

6.2.1 TV remote control setup

To use your TV remote control for both your TV and the soundbar, check that your TV supports HDMI-CEC. If your TV does not support HDMI-CEC, follow the steps under “TV remote control learning”.

HDMI-CEC

If your TV supports HDMI-CEC, enable the functions as instructed in your TV user manual. You can control the volume +/-, sound source, and power on/standby functions on your soundbar through the TV remote control.

TV remote control learning

Through IR learning, your Infra-red TV remote control can learn some commands of the soundbar.



1. Check that you have switched the soundbar to standby mode.
2. On the soundbar, press and hold \cup and + until the status indicator flashes amber.
 - You enter the TV remote control learning mode.
3. Within seconds, do the following on the soundbar and your TV remote control:
 - a) On the soundbar: press and hold one of the following buttons: +, -, \mathbb{G} and \cup , until the status indicator flashes red three times.
 - b) On your TV remote control: double press the desired button.
 - When the status indicator flashes amber on the soundbar, the function of the soundbar button is learnt by your TV remote control button.

4. Repeat Step 3 to complete the button learning.
5. To exit the TV remote control learning mode, press and hold  and **+** on the soundbar until the status indicator flashes amber three times.

6.3 Play from the HDMI IN source

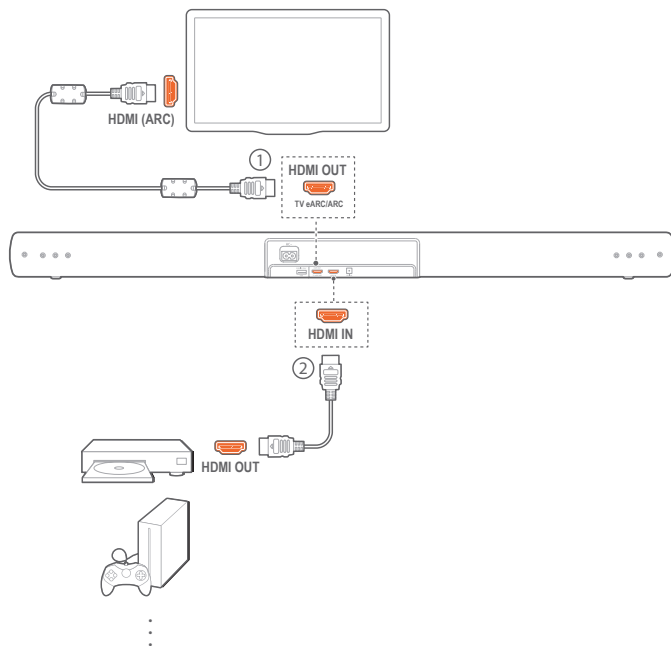
With the soundbar connected as shown, your digital device can play video on your TV and audio from the soundbar speakers.



1. Make sure that the soundbar has been properly connected to your TV and digital device (See “5.1 Connection with your TV and digital devices” in the “5 CONNECT” chapter).
2. Switch on your digital device.
 - Your TV and the soundbar wake up from standby mode and switch to the input source automatically.
 - To select the **HDMI IN** source on the soundbar, press  on the soundbar or **HDMI IN** on the remote control.
 - The status indicator turns solid yellow () if you play from the **HDMI IN** source.
3. Switch your TV to standby mode.
 - The soundbar and source device are switched to standby mode.



NOTES:

- Full compatibility with all HDMI-CEC devices is not guaranteed.

6.4 Play from the Bluetooth source

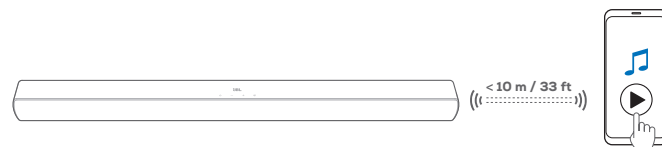
Through Bluetooth, stream audio from your Bluetooth device to the soundbar.



1. Check that the soundbar has been properly connected to your Bluetooth device (See “5.2 Bluetooth connection” in the “5 CONNECT” chapter).
2. To select the Bluetooth source, press  on the soundbar or  on the remote control.
3. Start audio play on your Bluetooth device.
4. Adjust the volume on the soundbar or your Bluetooth device.

7 SOUND SETTINGS

7.1 Dolby Atmos® (Virtual)

With the Virtual Dolby Atmos, enjoy height sound effects when you play movies in the HDMI IN/HDMI ARC source.

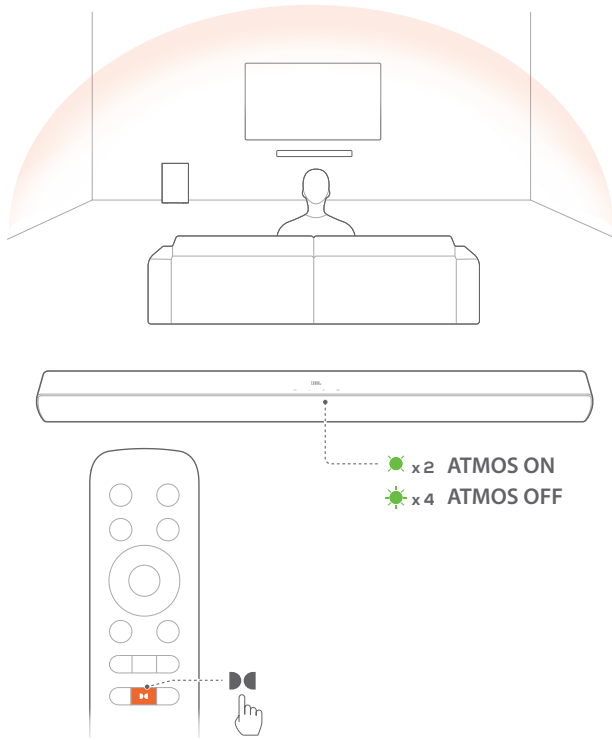

1. Connect and play your Blu-ray player or streaming device through the HDMI ARC/HDMI eARC connector and the HDMI connector. (See “5.1 Connection with your TV and digital devices” in the “5 CONNECT” chapter).
 - The status indicator turns solid green (●), if the Dolby Atmos audio content is playing on the soundbar.
2. Press **⏮** on the remote control to switch on or off the height sound effects (Default: on).
 - The status indicator flashes green slowly twice (●), if the Dolby Atmos sound effect is enabled on the soundbar.
 - The status indicator flashes green quickly four times (●), if the Dolby Atmos sound effect is disabled on the soundbar.

NOTES:

- Switch off the ATMOS effects, if you prefer not to have any height sound effects during your viewing or listening

7.2 Pre-defined EQ settings

With the remote control, select the pre-defined EQ (equalizer) settings for your audio playback.

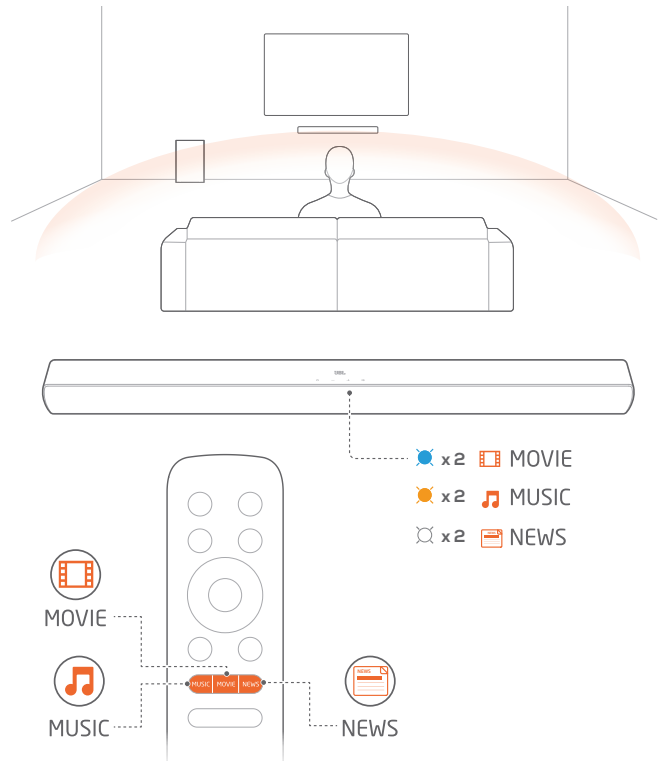

- **MOVIE:** sound mode for movies
 - The status indicator flashes blue slowly twice (●), if the movie mode is enabled on the soundbar.
- **MUSIC:** sound mode for music
 - The status indicator flashes amber slowly twice (●), if the music mode is enabled on the soundbar.
- **NEWS:** sound mode for TV programs such as news and weather forecasts
 - The status indicator flashes white slowly twice (●), if the news mode is enabled on the soundbar.

7.3 Voice mode

The voice mode allows you to enhance vocal clarity and easily hear and understand speech.

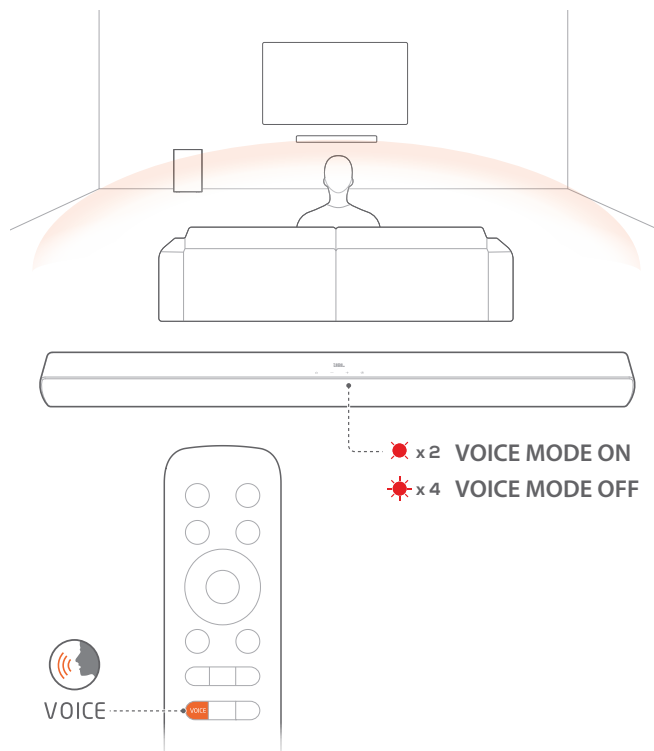

- On the remote control, press **VOICE** to switch the voice mode on or off.
 - The status indicator flashes red slowly twice (●), if the voice mode is enabled on the soundbar.
 - The status indicator flashes red quickly four times (★), if the voice mode is disabled on the soundbar.

7.4 Bass boost

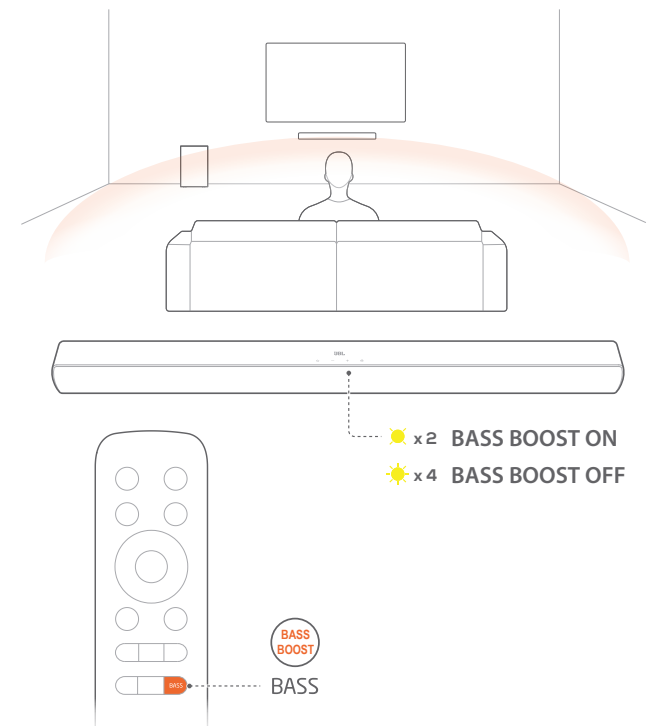

By switching the bass boost on or off, you can increase or decrease the bass sound effect.



- On the remote control, press **BASS** to switch the bass boost on or off (Default: on).
 - The status indicator flashes yellow slowly twice (●), if the bass boost is enabled on the soundbar.
 - The status indicator flashes red quickly four times (★), if the bass boost is disabled on the soundbar.

8 RESTORE FACTORY SETTINGS

By restoring the default settings defined at factories, you remove all your personalized settings from the soundbar.





- On the soundbar, press and hold  and  for more than 10 seconds.

9 SOFTWARE UPDATE

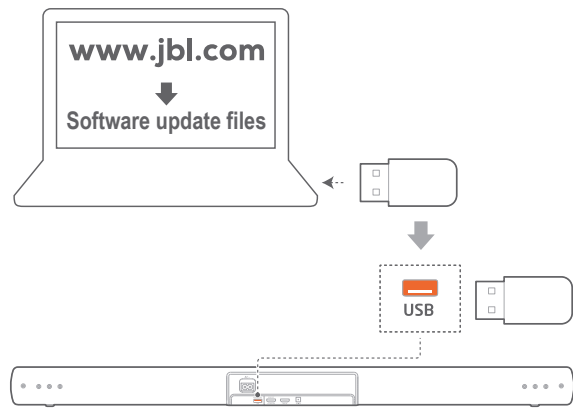
For optimal product performance and your best user experience, JBL may offer software updates for the soundbar system in the future. Please visit www.jbl.com or contact JBL call center to receive more information about downloading update files.



1. Check that you have saved the software update file to the root directory of a USB storage device. Connect the USB device to the soundbar.
 - Make sure that your USB storage device meets the following requirements:
 - Maximum capacity: 64 GB
 - File system: FAT32

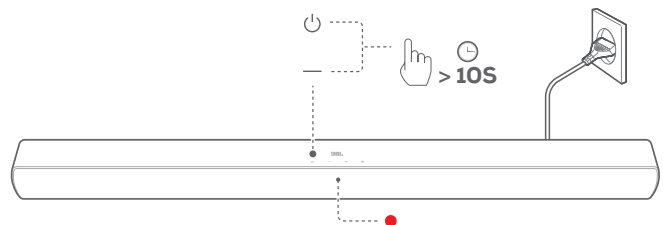

2. To enter the software update mode,
 - a) check that you have switched the soundbar to standby mode.
 - b) press and hold  and  on the soundbar for more than 10 seconds.
 - : software updating starts
 - : software updating in progress
 - : software updating complete
 - The soundbar returns to standby mode.



NOTES:



- Keep the soundbar powered on and the USB storage device mounted before software updating is complete.
- If the software updating file is missing or damaged,  or  are displayed and then, the soundbar goes to standby mode.

10 RE-CONNECT THE SUBWOOFER

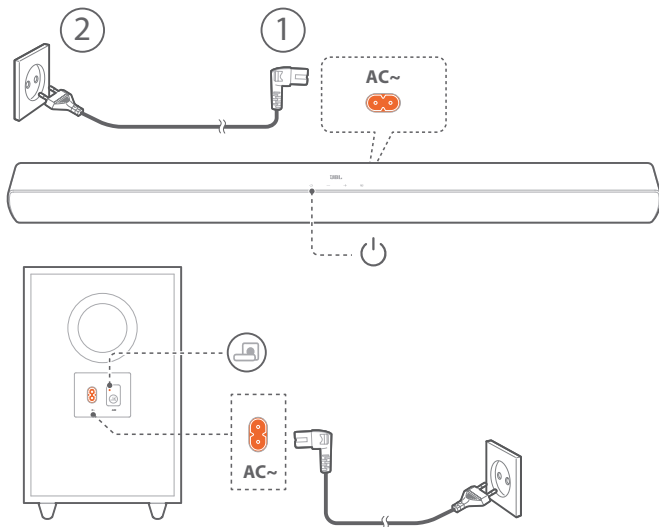
The soundbar and subwoofer are paired at factories. After power-on, they are paired and connected automatically. In some special cases, you may need to pair them again.



To re-enter the subwoofer pairing mode

1. On the subwoofer, press and hold  until the connection status indicator turns fast flashing amber (●).
2. On the soundbar, press  to switch on.
→ The subwoofer is connected to the soundbar automatically.
Connected: The connection status indicator turns solid amber (●).

NOTES:

- If the wireless connection fails again, check if there is a conflict or strong interference (e.g. interference from an electronic device) around the location. Remove these conflicts or strong interferences and repeat the above procedures.

11 PRODUCT SPECIFICATIONS

General specification:

- Power supply: 100 - 240V AC, ~50/60Hz
- Total speaker power output (Max. @THD 1%): 380 W
- Soundbar power output (Max. @THD 1%): 2 x 90 W
- Subwoofer power output (Max. @THD 1%): 200 W
- Soundbar transducer: 2x (48 x 90) mm racktrack driver + 2x 1.25" tweeter
- Subwoofer transducer: 6.5", wireless sub
- Standby consumption: < 0.5 W
- Operating temperature: 0 °C - 45 °C

HDMI specification:

- HDMI Video input: 1
- HDMI Video output (With Enhanced Audio Return Channel, eARC): 1
- HDMI HDCP version: 2.3

Audio specification:

- Frequency response: 40 Hz - 20 kHz
- Max SPL: 96 dB
- Audio inputs: 1 Optical, Bluetooth, USB (USB playback is available in US version. For other versions, USB is for Service only.)

USB specification:

- USB port: Type A
- USB rating: 5 V DC, 0.5 A
- Supporting file format: mp3
- MP3 Codec: MPEG 1 Layer 1/2/3, MPEG 2/2.5 Layer 1/2/3
- MP3 sampling rate: 8 kHz - 48 kHz
- MP3 bitrate:
 - MPEG 1 Layer 1: 32 kbps - 448 kbps;
 - MPEG 1 Layer 2: 32 kbps - 384 kbps;
 - MPEG 1 Layer 3: 32 kbps - 320 kbps;
 - MPEG 2/2.5 Layer 1: 32 kbps - 256 kbps;
 - MPEG 2/2.5 Layer 2/3: 8 kbps - 160 kbps

Wireless specification:

- Bluetooth version: 5.1
- Bluetooth profile: A2DP V1.3, AVRCP V1.5
- Bluetooth frequency range: 2400 MHz - 2483.5 MHz
- Bluetooth Max. transmitting power: < 0 dBm (EIRP)
- Bluetooth modulation: GFSK, $\pi/4$ DQPSK
- 2.4G wireless frequency range: 2400 MHz - 2483 MHz
- 2.4G Max. transmitting power: 3 dBm
- 2.4G wireless modulation: GFSK

Dimensions:

- Dimensions (W x H x D):
(900 x 62 x 67) mm / 35.4" x 2.44" x 2.6" (soundbar);
(200 x 409 x 280) mm / 7.87" x 16.1" x 11" (subwoofer)
- Weight: 1.9 kg (soundbar); 5.6 kg (subwoofer)
- Packaging dimensions (W x H x D):
(990 x 230 x 400) mm / 38.98" x 9.06" x 15.75"
- Packaging weight (Gross weight): 9.7 kg

12 TROUBLESHOOTING

Never try to repair the product yourself. If you have problems using this product, check the following before you request services.

System

The unit will not turn on.



- Check if the power cord is plugged into power and the soundbar.

The soundbar has no response to button pressing.

- Restore the soundbar to factory settings (See the "8 RESTORE FACTORY SETTINGS" chapter).

Sound

No sound from the soundbar

- Make sure that the soundbar is not muted.
- Select the correct audio input source on the remote control.
- Connect the soundbar to your TV or other devices properly.
- Restore the soundbar to its factory settings by pressing and holding  and  on the soundbar for more than 10 seconds.

Distorted sound or echo

- If you play audio from your TV through the soundbar, make sure that your TV is muted or the built-in TV speaker is disabled.

No height sound effects of Dolby Atmos

- If your TV supports HDMI ARC only, make sure that you have connected your digital device to the soundbar through the **HDMI IN** connector on the soundbar (See "TV (HDMI ARC)" under "5.1 Connection with your TV and digital devices" in the "5 CONNECT" chapter)
- Enjoy the sound effects of Dolby Atmos when you play movies from the TV / HDMI source. For audio streaming over Bluetooth, Dolby Atmos is not supported.

Bluetooth

A device cannot be connected with the soundbar.

- Check if you have enabled Bluetooth on the device.
- If the soundbar has been paired with another Bluetooth device, reset Bluetooth (see "To connect to another Bluetooth device" under "5.2 Bluetooth connection").
- If your Bluetooth device has ever been paired with the soundbar, reset Bluetooth on the soundbar, unpair the soundbar on the Bluetooth device, and then, pair the Bluetooth device with the soundbar again (see "To connect to another Bluetooth device" under "5.2 Bluetooth connection").

Poor audio quality from a connected Bluetooth device

- The Bluetooth reception is poor. Move the source device closer to the soundbar, or remove any obstacle between the source device and the soundbar.

The connected Bluetooth device connects and disconnects constantly.

- The Bluetooth reception is poor. Move the source device closer to the soundbar, or remove any obstacle between the source device and the soundbar.
- For some Bluetooth devices, the Bluetooth connection can be deactivated automatically to save power. This does not indicate any malfunction of the soundbar.

Remote control

The remote control does not work.

- Check if the batteries are drained. If so, replace them with new ones.
- Reduce the distance and angle between the remote control and the main unit.

Failed to complete the TV remote control learning.

- Check if you are using an infra-red TV remote control. The IR learning is not supported by a Bluetooth TV remote control.

13 TRADEMARKS



The Bluetooth® word mark and logos are registered trademarks owned by Bluetooth SIG, Inc. and any use of such marks by HARMAN International Industries, Incorporated is under license. Other trademarks and trade names are those of their respective owners.



The terms HDMI, HDMI High-Definition Multimedia Interface, and the HDMI Logo are trademarks or registered trademarks of HDMI Licensing Administrator, Inc.



Dolby, Dolby Atmos, and the double-D symbol are registered trademarks of Dolby Laboratories Licensing Corporation. Manufactured under license from Dolby Laboratories. Confidential unpublished works. Copyright © 2012-2020 Dolby Laboratories. All rights reserved.



HARMAN International Industries,
Incorporated 8500 Balboa Boulevard,
Northridge, CA 91329 USA
www.jbl.com

© 2021 HARMAN International Industries, Incorporated.
All rights reserved.

JBL is a trademark of HARMAN International Industries, Incorporated, registered in the United States and/or other countries. Features, specifications and appearance are subject to change without notice.